

The graphene revolution & graphene-based radiation detector

Seminar talk for the Doctoral School in Physics

Laura Zani



Pisa, 21/09/2017

Outline

- The 2D revolution: graphene is real
- Graphene electronic properties
- Possible application for radiation detection
- A Graphene Field Effect Transistor device
- Conclusions

2004: the 2D revolution

Graphene: is a flat monolayer of carbon atoms packed into a 2D honeycomb lattice.

- Theoretically known for more than 60 years, used as (2+1)D QED toy model
- In 2004, experimentally discovered:
 - Possible to grow it on non-crystalline substrates
 - Stable against curve structure formation and thermal fluctuations
 - Charge carriers are massless Dirac fermions

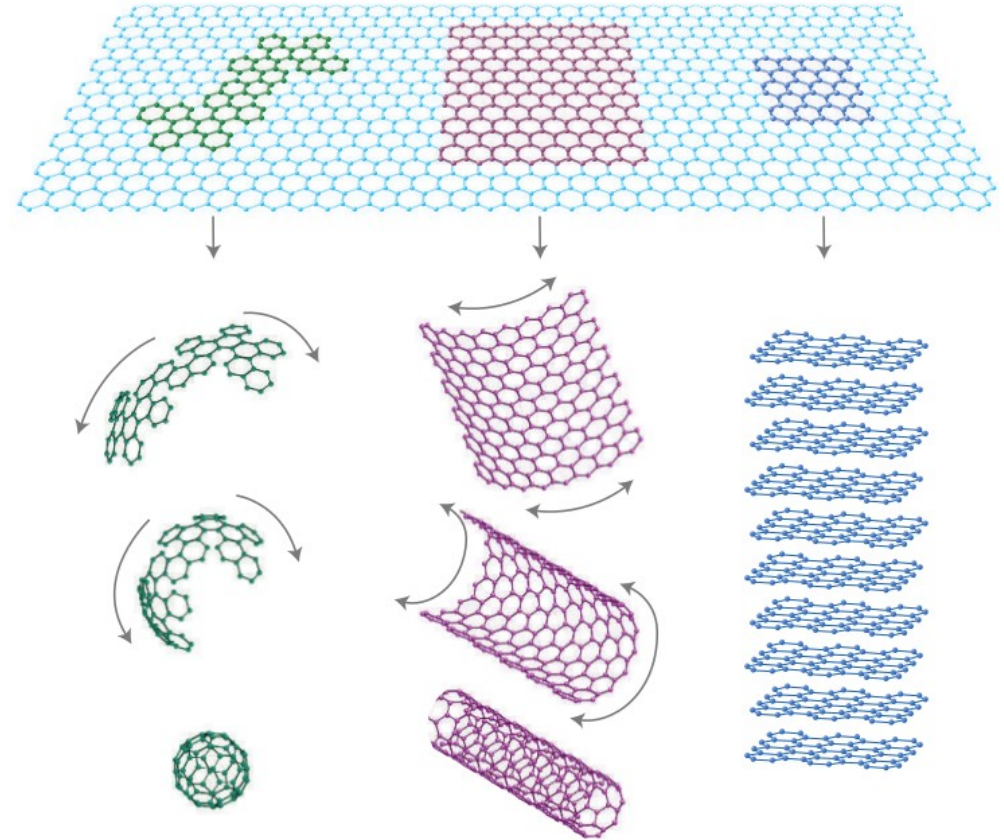

A.K. Geim and K.S. Novoselov., "The Rise of Graphene" Nature Materials, vol. 6, no. 3, pp. 183-191, March 2007

2D crystals

2D

One atom thick material,
2-layer, 3-layer graphene...

10 layers



3D

100 layers

It depends on the **electronic properties and structure**, evolving with #layers
→ up to 10 layers, materials have been proved as *different types* of 2D graphene.

2D crystals (II)

- Monolayer graphene:
 - very simple electron spectra,
 - ZERO-bandgap semiconductor, with *massless* charge carriers
 - Grown epitaxially by chemical vapour deposition

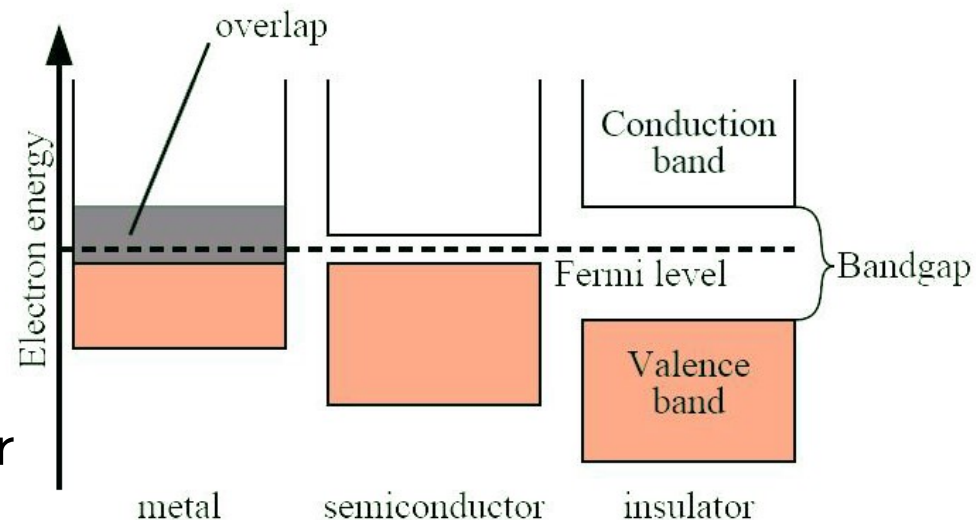

- Bilayer graphene: massive Dirac fermions
- $3 < \text{layer} < 10$ graphene \rightarrow *several charge carriers* appear, overlap between conduction and valence band starts
- > 10 layers \rightarrow graphite

Electronic properties

- **Linear energy dispersion** around the *Dirac point*
- **Zero-bandgap** semiconductor, behaving like a metallic material
- Very high crystal quality

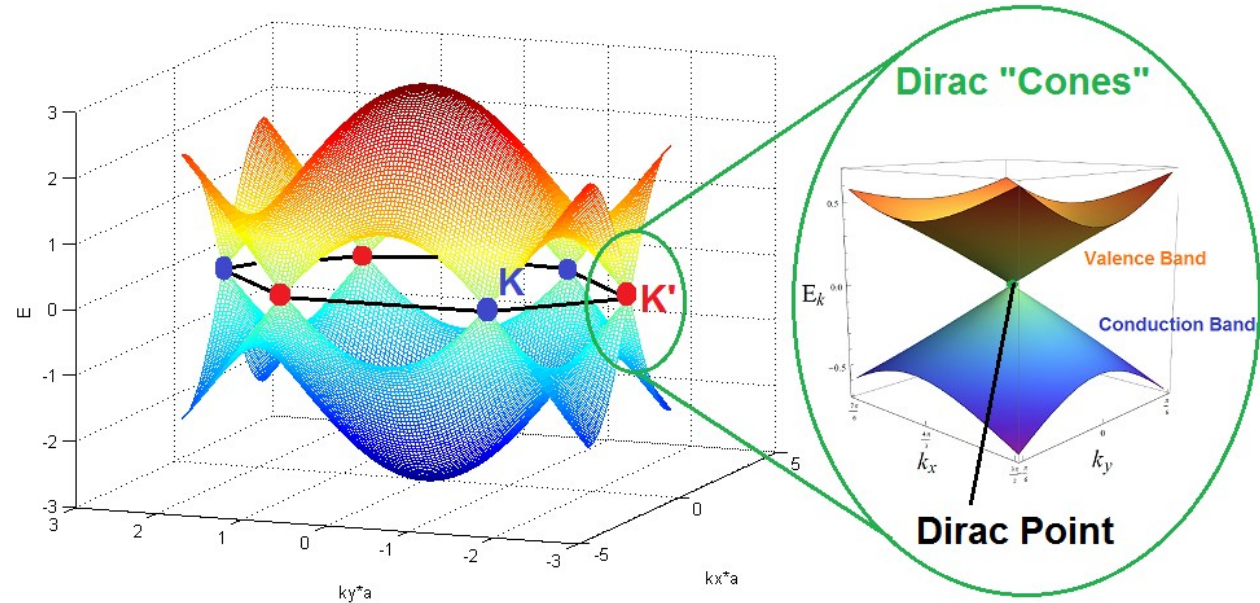

	Graphene	Silicon
Mobility (300 K) [cm^2/Vs]	15000	1400 (e), 500 (h)
Intrinsic carrier density	10^{13} cm^{-2}	10^{10} cm^{-3}

- High mobility μ at 300K,
 - weakly dependent on T and on the carriers concentration n , limited only by impurity scattering
- μ can reach 230 000 cm^2/Vs \rightarrow BALLISTIC TRANSPORT

QED-like spectrum

→ Collective motion of electrons in a periodic potential gives rise to low-energy *quasi-particles* with zero mass and $v_F \sim 10^6$ m/s, well described by the relativistic Dirac equation.

→ Electronic properties of graphene arise from this peculiar behavior: their measurement ***probe the QED.***

$$\hat{H} = \hbar v_F \begin{pmatrix} 0 & k_x - ik_y \\ k_x + ik_y & 0 \end{pmatrix} = \hbar v_F \boldsymbol{\sigma} \cdot \mathbf{k}$$

- At the Dirac point, states belong to two different sublattices (A, B) → quasi-particles described by two-component wavefunctions (***pseudospin, $\boldsymbol{\sigma}$***).
- **Chirality** can be defined as the pseudospin projection along the direction of motion \mathbf{k} .

→ Many electronic processes derive from *chirality* and *pseudospin* conservation.

Further astonishment: Quantum Hall Effect...

Quantum Hall Effect = quantum-mechanical version of Hall effect, observed in 2D electron systems at low T and subjected to strong magnetic field → conductivity σ_{xy} has quantized values, being i an integer or a fractional number.

$$\sigma_{xy} = ie^2/h$$

Monolayer graphene

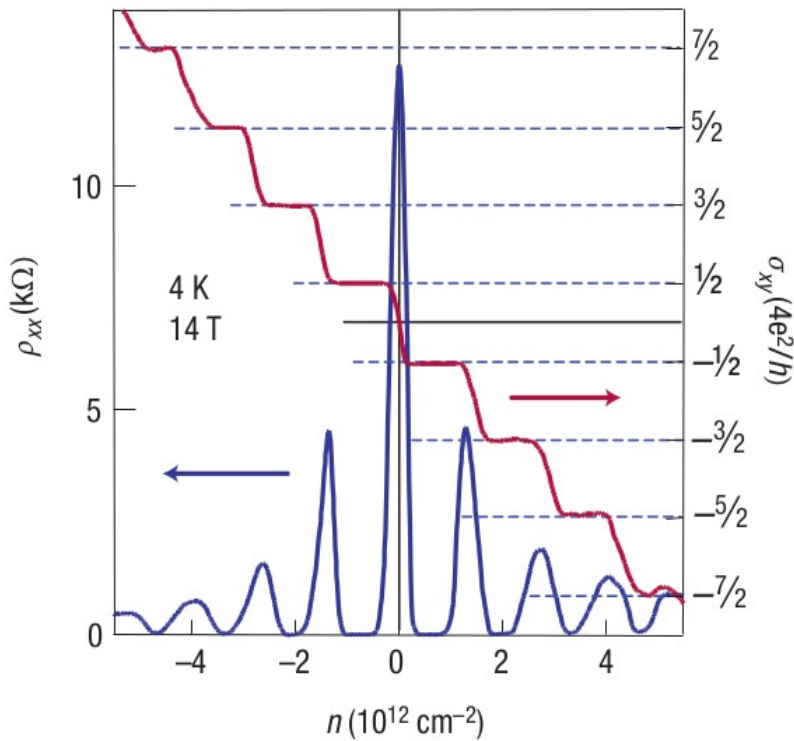

$$\sigma_{xy} = 4e^2/h(N + 1/2)$$

Bilayer graphene

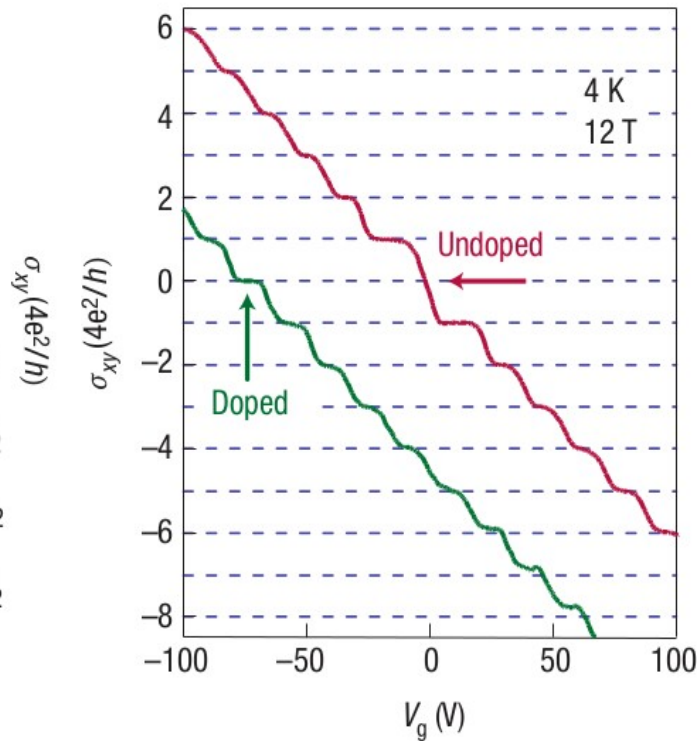

N=0 missing

$$\sigma_{xy} = 4Ne^2/h$$

Landau Level quantizations
in graphene

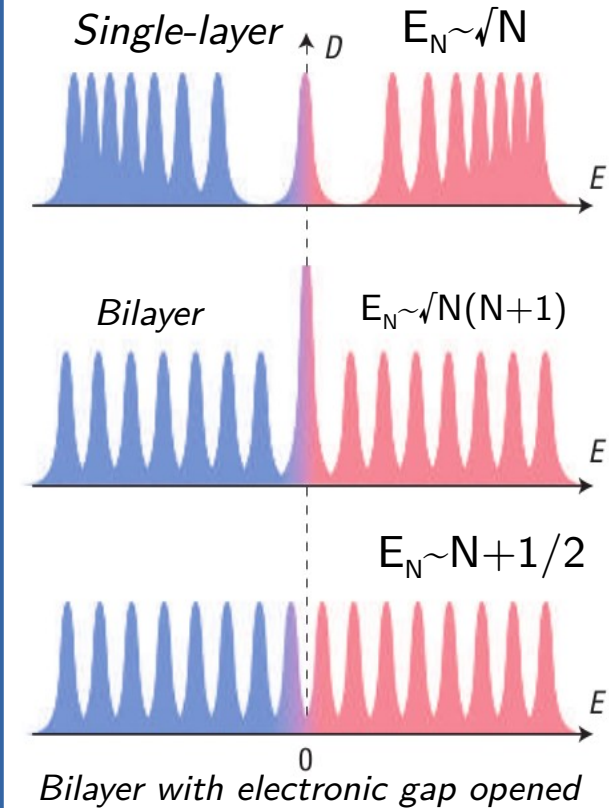

... and non vanishing conductivity

- Conductivity σ_{xy} at the Charge Neutrality Point (CNP) should be zero, leading to a metal-insulator transition, as observed in any other material.

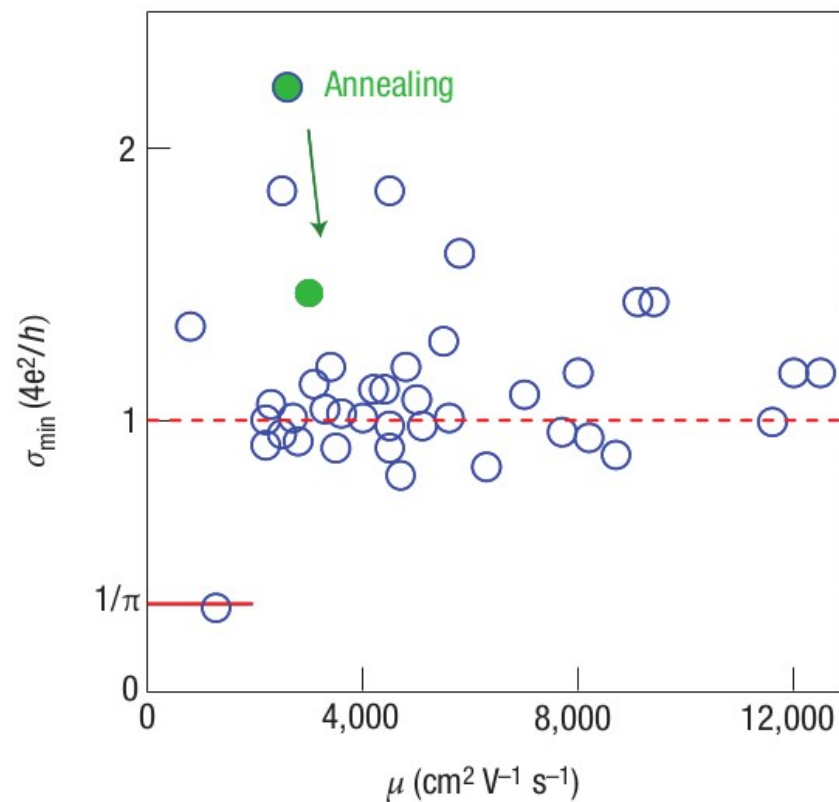

INSTEAD:

- Measurements down to liquid helium T cluster around $\sigma_{\min} = 4e^2/h$
- It's a *chirality* effect: observed in both massless (single-layer) and massive (bilayer) Dirac fermions.
- Theories predict $\sigma_{xy} = 4e^2/h\pi$

Possible Applications

- **Graphene-based electronics**, graphene as conductive sheet or used in composite materials.

PROS

- High mobility
- Mobility is stable against **high increase** of carriers concentrations
- Ballistic transport down to sub- μm scale at 300K

Ballistic transistors at room temperature

CONS

- Minimum conductivity, slow on-off ratios
- Graphene behaves as metal also at CNP

Gaps can be induced in doped bilayer graphene, or with spatial confinement of single-layer graphene

Graphene-based Radiation Detectors

- Motivation: achieving high energy resolution at room temperature
- The idea: exploiting graphene high sensitivity to local change of electrical field, induced by radiation interaction with a semiconductor substrate
- The proposed device: a Graphene Field Effect Transistor (GFET)

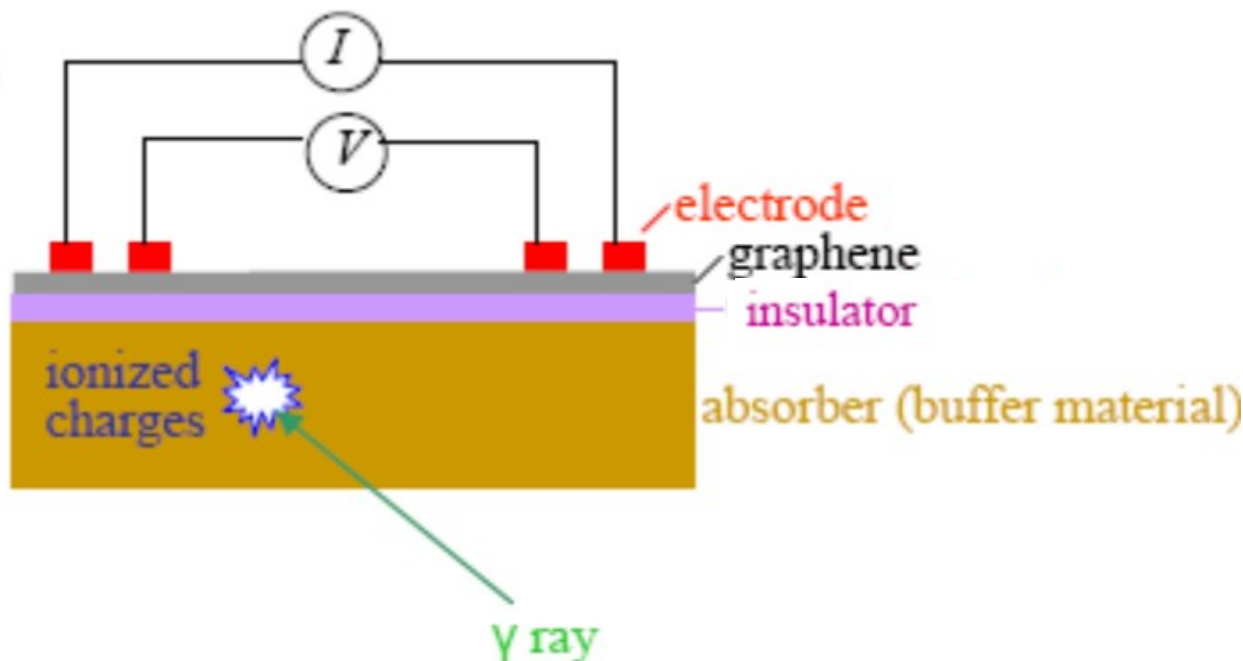

→ The electrical conductivity of graphene shows a sharp dependence on small changes in electric field, due to ionizing radiation through an absorber material.

GFET: principle of working

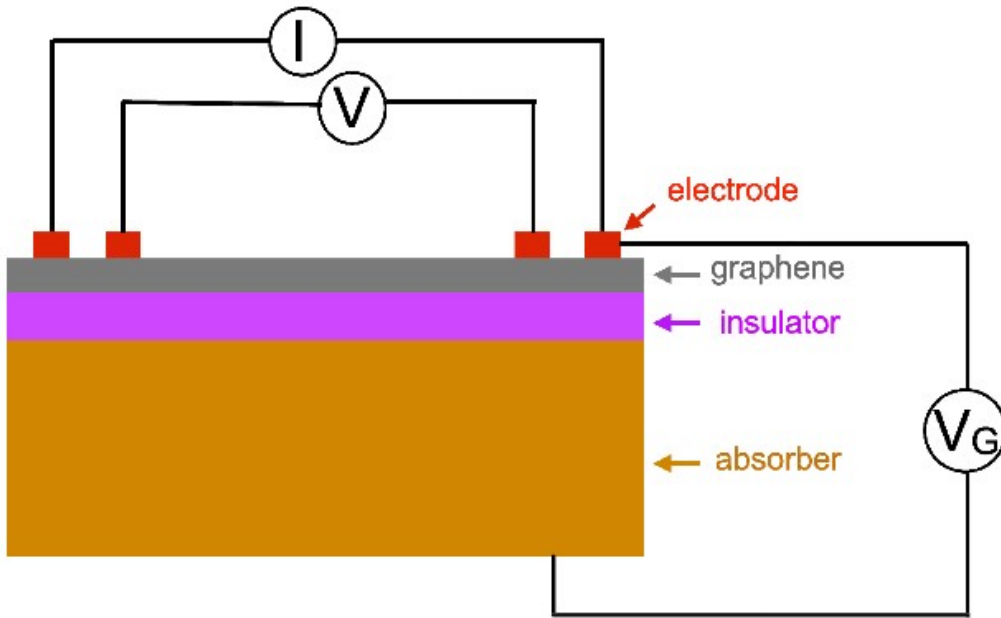

- Single-layer graphene coupled with a (semiconductor) **absorber** through an insulator buffer layer.
- **4 electrodes**, two of them supplying *constant current* through graphene and two measuring the *voltage drop* across the graphene → monitoring the **resistance**.
- The **electric field** is applied through a *gate voltage* between graphene and the back of absorber.

- **2 detection modes:**

- 1) without charge drift (ionization-induced change of **E**)
- 2) with charge drift (providing energy resolution)

→ The electric field changes due to resistivity alteration of the absorber caused by the interaction with the ionizing radiation.

Insulator substrate

Using an insulator absorber (*undoped Si* substrate), the voltage drops across all the device thickness resulting in a smaller field, $E \sim V/d \rightarrow$ significantly altered by the change of the absorber conductivity due to the interacting radiation.

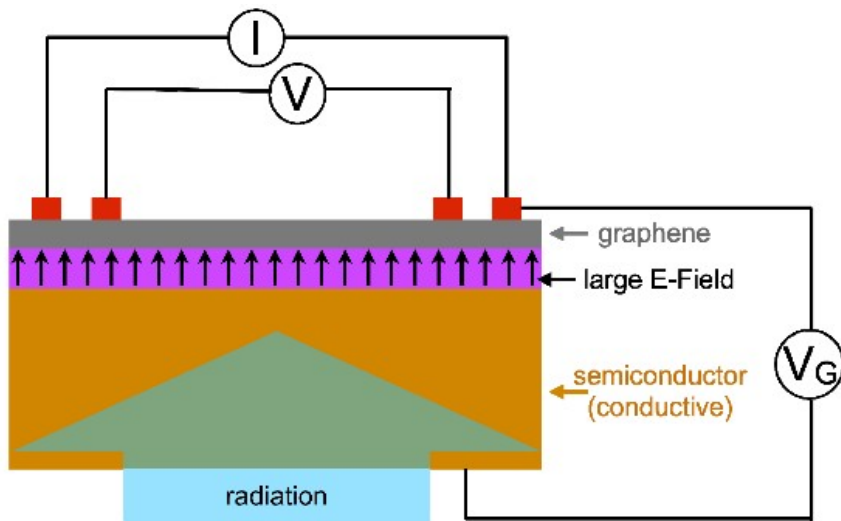

Fig. 4. The incoming radiation ionizes the charges within the (intrinsic) semiconductor to create a conducting absorber. The gate voltage is now effective “transferred” through the absorber and only drops across the insulator. This results in an increased electric field to be detected by the graphene and the resistance changes according to the increased electric field.

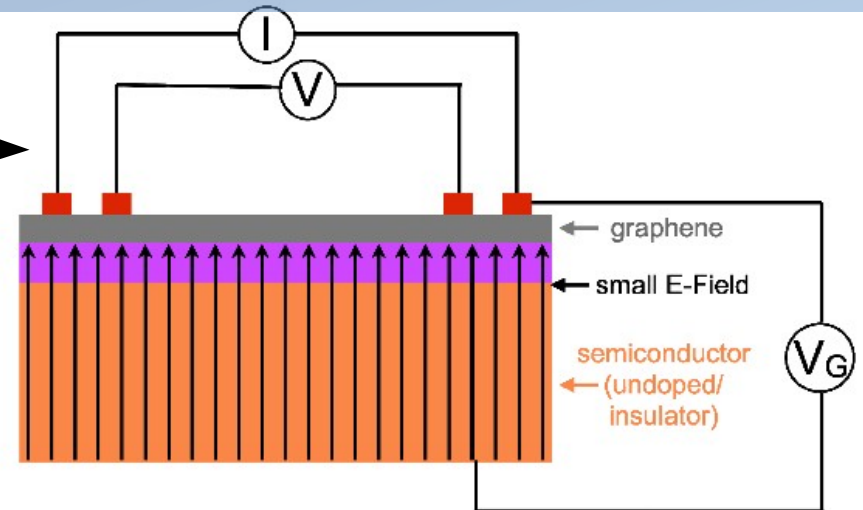
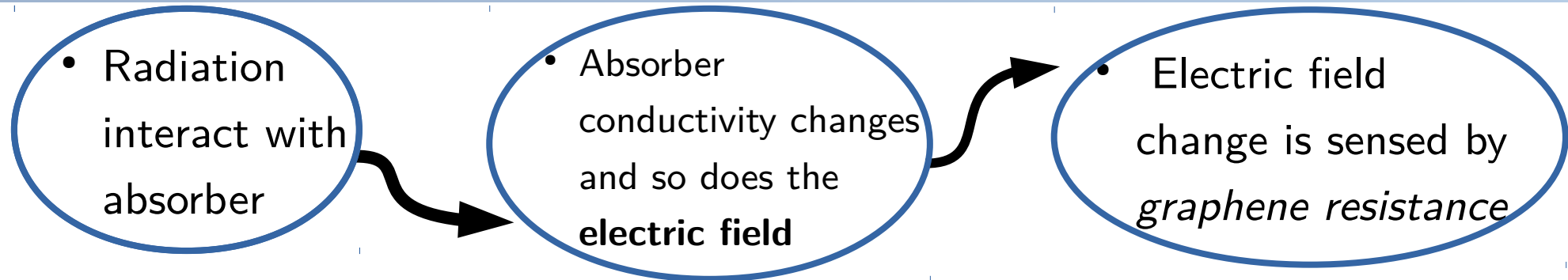

Fig. 3. When the absorber acts as an insulator, the gate voltage drops across both the absorber and the insulator, resulting in a small electric field. With an electric field strength corresponding to the Dirac point, the graphene resistance is at a maximum.

Conductive semiconductor reduces the voltage drop to the oxide buffer thickness and increase the electric field.

Detection mode I: without charge drift



Transient change in the resistance is used to detect the passage of an interacting particle!

- But how to improve *resolution* on the energy measurement?
- One-particle event usually provides *not-uniform ionization*
 - charge deposition morphology is highly random
 - transient change in resistance is very poorly correlated with the deposited energy

→ Drift the charges towards the absorber surface

Detection mode II: with charge drift

- A **drift electric field** is applied through V_G between the back of the absorber and graphene
- Electrons are driven to the layer under the graphene, independently on where they were produced
- Electric field response only depends on the **number of collected charges** → related to the **total deposited energy** in the absorber

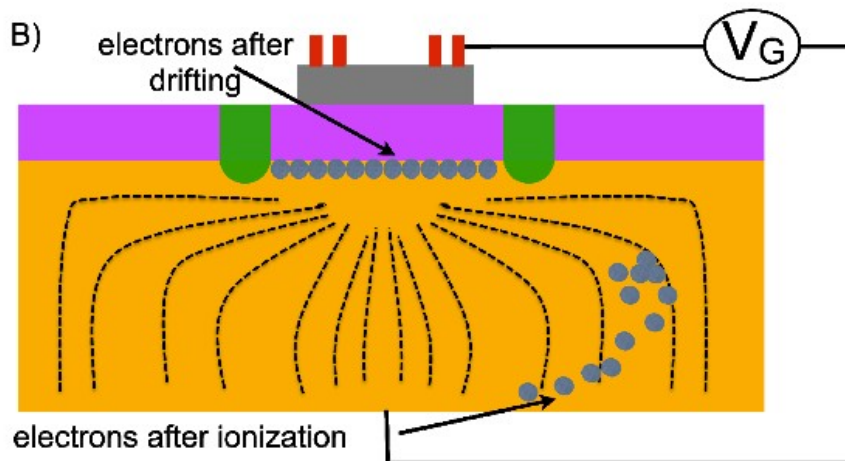
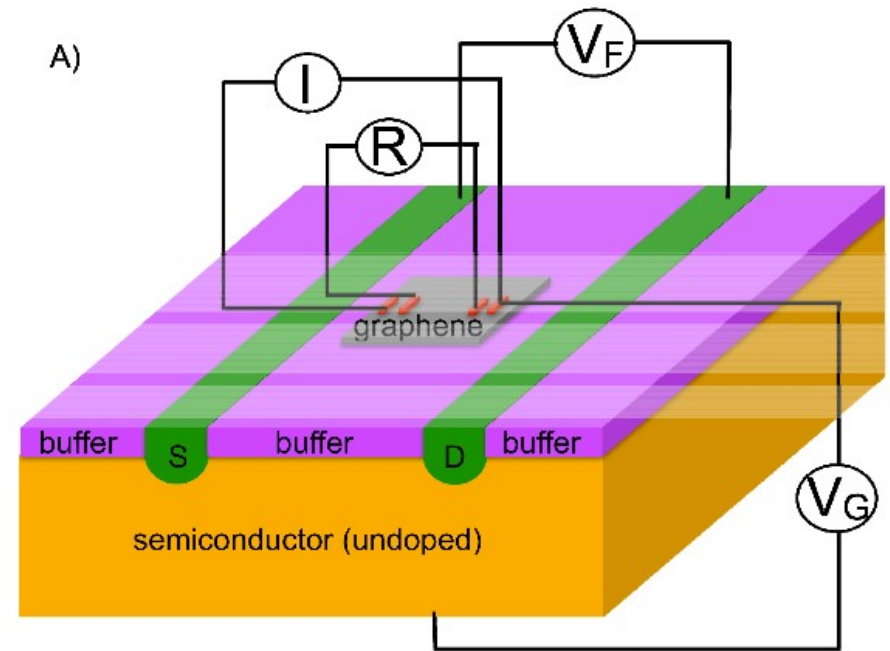

- Small *reset voltage* V_F applied horizontally between source and drain, to remove electrons after collection
→ *Constant current* applied to graphene and the resistance change is monitored.

Simulated device

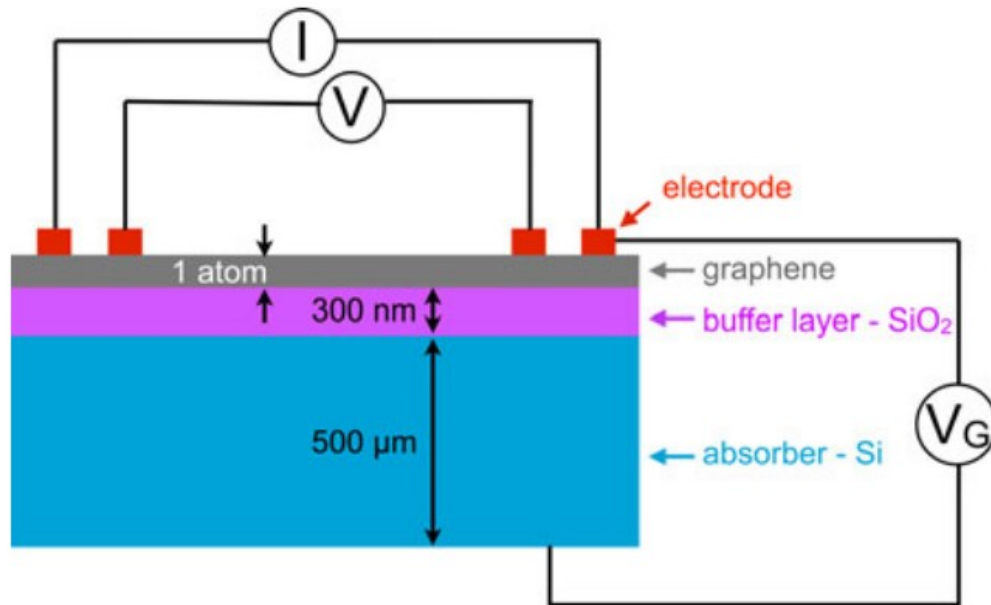

- Si-based GFET, with a 1 MeV γ -ray source 1 cm from the bottom of the absorber, emitting into 4π solid angle
- Energy deposited is calculated and electron trajectories in Si are simulated thanks to CASINO simulation packages**
- The electric field response is also modeled

** P. Hovington et al., Scanning, vol. 19, no. 1, pp. 1-14, Jan, 1997

Device model: square-shaped highly insulating intrinsic silicon substrate ($500 \mu\text{m} \times 500 \mu\text{m}$) with a SiO_2 top layer ($500 \mu\text{m} \times 300 \text{nm}$)

Simulation results

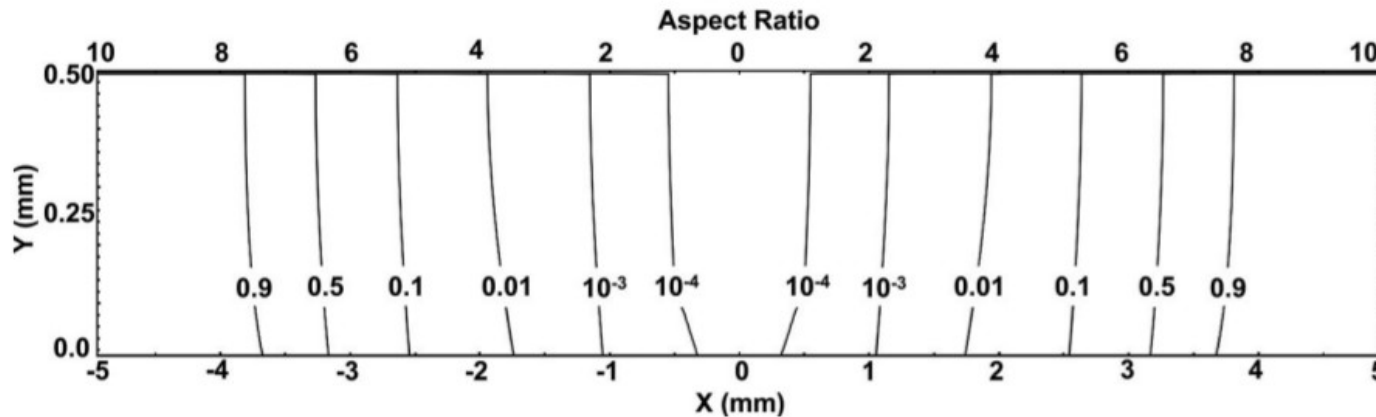

Electron recombination probability, @ $V_G = -100$ V

- The *aspect-ratio* (width/thickness) of the absorber strongly affects electron recombination probability, increasing with surface area of the absorber → important for **high-energy resolution** and **speed** to keep a low aspect-ratio.

→ simulation results: ionizing events are able to modulate the electric field in the oxide layer ($\sim 10^6$ - 10^7 V/m) which produces a substantial and measurable change in the GFET resistance.

Energy resolution



- Intrinsic Poissonian fluctuation
 $\sim\sqrt{F/N}$
 - $F=0.115$, Fano factor for Si
 - Assuming W -value = 3.65 eV

- Detector architecture limitations:
 - Charge trapping (linear function of distance)
 - Loss of charge
 - Noise in resistance measurement

Energy resolution

- Intrinsic Poissonian fluctuation
 $\sim \sqrt{F/N}$
 - $F=0.115$, Fano factor for Si
 - Assuming W -value = 3.65 eV

- Detector architecture limitations:
 - Charge trapping (linear function of distance)
 - Loss of charge
 - Noise in resistance measurement

Contribution from the *loss of charge* due to recombination depends on the aspect-ratio:

- 1 \rightarrow 0.01%
- 2 \rightarrow 0.1%

- From the derivative of Dirac curve ($\delta R/\delta n$), the energy resolution (η) associated with the resistance noise in graphene is then calculated as:

$$\frac{\delta n A_g}{U/W} = \eta \quad \text{With} \quad \delta n = \frac{\sqrt{\frac{\delta R^2}{R^2}} R}{\frac{\delta R}{\delta n}}$$

Energy resolution (II)

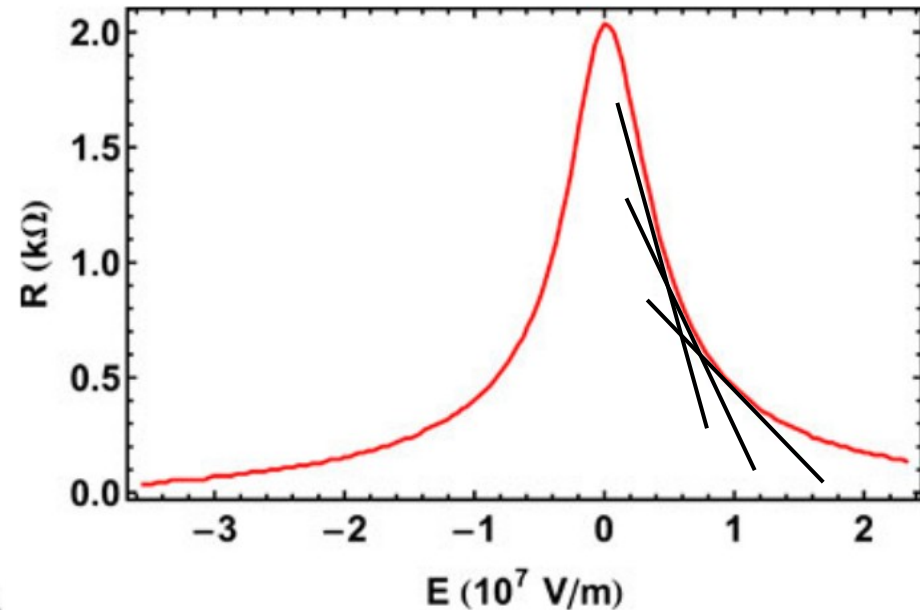
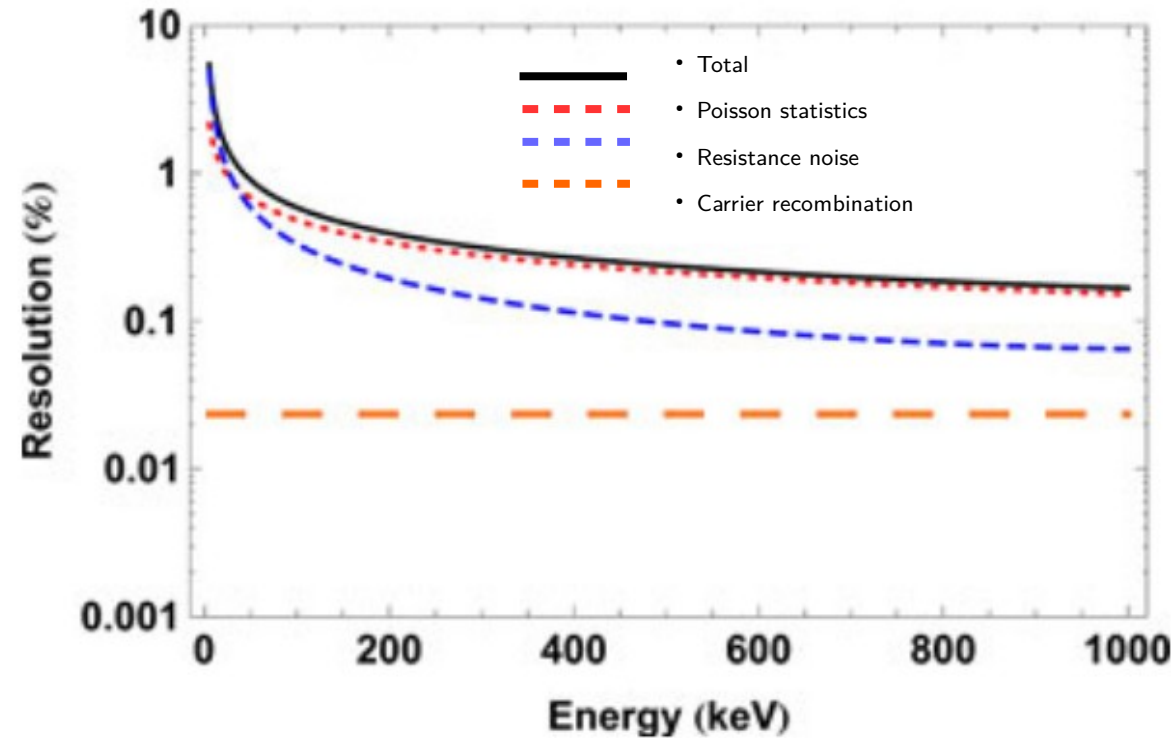

- The total energy resolution is the result of two competitive trends:
 - The decrease of the graphene resistance as the energy release increases.
 - The decrease of the Dirac curve slope with increasing energy, resulting in larger uncertainty on charge density measurement.
- For $E > 50$ keV, Poisson fluctuations dominate.

Conclusion

Graphene-based sensors have been proved to offer many advantages with respect to **traditional** sensors:

- Sharp resistance change induced by external electric field modulation → **BUILT-IN PREAMPLIFIER**
- *Detector* (graphene) decoupled from the *absorber* (substrate) → more **flexibility** in the absorber choice.
- Ultra-low **electrical noise**: high graphene conductivity, also at Dirac point where it reaches its minimum (maximum resistivity), allows a significant noise reduction.
- Relatively easy fabrication, can be deposited on various absorber.

→ avoid material budget, bump bonding limitations due to the necessity of "physically" bond electronics (readout chip) and the sensor.

→ no stringent requirements on absorber purity and carrier mobility/lifetime

References

- A.K. Geim and K.S. Novoselov., "The Rise of Graphene" Nature Materials, vol. 6, no. 3, pp. 183-191, March 2007.
- Foxe, Michael, et al. "Detection of ionizing radiation using graphene field effect transistors." Nuclear Science Symposium Conference Record (NSS/MIC), 2009 IEEE. IEEE, 2009.
- Foxe, Michael, et al. "Graphene field-effect transistors on undoped semiconductor substrates for radiation detection." IEEE Transactions on Nanotechnology 11.3 (2012): 581-587.
- Magdalena Wojtasze, "Graphene: a two type charge carrier system", Master Thesis, Rijksuniversiteit Groningen, July 2009.